

VOLVO WHEEL LOADERS

**L60F, L70F, L90F**



# GET THE JOB DONE. GET A VOLVO

"Get the job done" has defined Volvo ever since inventing and refining the wheel loader concept more than half a century ago. The F-series' quiet, fast, and safe allrounders set a whole new standard when it comes to operating joy. A lot of that is due to the new quiet, environment-friendly engine, smooth shifting Automatic Power Shift (APS) transmission, and roomier comfort cab with optimized visibility.

## Versatile high-performers

It is easier to do a good job in a Volvo. The new Care Cab is the safest, most comfortable, and cleanest operator's station we've built. From here, the operator has precision-control of the attachments with the TP-linkage and load-sensing hydraulics. The in-house manufactured engine, transmission, and steering always give instant response. Volvo L60F, L70F, and L90F have a built-in smoothness that gives faster work cycles and makes operating with different attachments a whole new experience.

## Reliable and totally economical

When you buy a Volvo, you get a highly reliable and productive wheel loader. Volvo's wheel loaders are also characterized by low fuel consumption, quick and easy maintenance, and high resale value. All in all, this gives world class total economy. You have a reliable partner in our global dealer and service network. We are ready to assist you with knowledge, genuine spare parts, and well-trained service personnel.

Specifications	L60F	L70F	L90F
Engine:	Volvo D6E LCE3	Volvo D6E LBE3	Volvo D6E LAE3
Max power at	28,3 r/s (1700 rpm)	28,3 r/s (1700 rpm)	28,3 r/s (1700 rpm)
SAE J1995 gross:	115 kW (156 metric hp)	126 kW (171 metric hp)	129 kW (175 metric hp)
ISO 9249, SAE J1349 net:	114 kW (155 metric hp)	125 kW (170 metric hp)	128 kW (174 metric hp)
Breakout force:	82,9 kN*	95,4 kN**	118,5 kN***
Static tipping load at full turn:	7380 kg*	8420 kg**	9570 kg***
Buckets:	1,6-5,0 m <sup>3</sup>	2,0-6,4 m <sup>3</sup>	2,1-7,0 m <sup>3</sup>
Log grapples:	0,7-1,3 m <sup>2</sup>	0,9-1,5 m <sup>2</sup>	1,3-2,4 m <sup>2</sup>
Operating weight:	11,0-13,3 t	12,7-15,0 t	15,0-17,0 t
Tires:	17.5 R25, 20.5 R25 / 600/65 R25	20.5 R25 600/65 R25	20.5 R25 650/65 R25

\* Bucket: 2,1 m<sup>3</sup> (pin-on) with bolt-on edges, Tires: 20.5 R25 L2, Std. boom

\*\* Bucket 2,3 m<sup>3</sup> (pin-on) with bolt-on edges, Tires: 20.5 R25 L2, Std. boom

\*\*\* Bucket 2,5 m<sup>3</sup> (pin-on) with bolt-on edges, Tires: 20.5 R25 L2, Std. boom

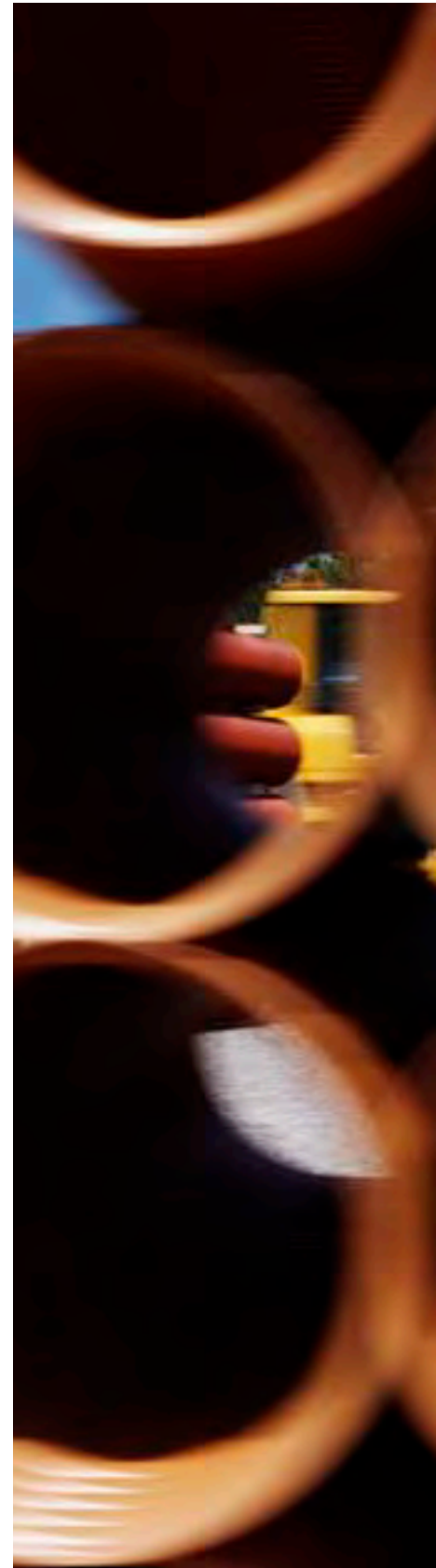



# “F” FOR FLEXIBILITY

Many have tried to copy Volvo's successful allrounder concept. Nobody has been able to do it. Usability is based on fast and easily operated wheel loaders. Add the TP-linkage's high breakout torque and parallel movement throughout the entire lifting range, the smart hydraulic attachment bracket, and the market's widest range of genuine attachments, and you get a machine for all applications.

## Highly manoeuvrable L60F

Even though Volvo L60F has grown, it is still highly manoeuvrable and easy to operate in tight quarters. The allround L60F has the power needed to handle various and fast-changing applications on construction sites, in industries, for municipalities, in gravel pits, and agriculture.

## Allrounder L70F

The Volvo L70F is built for tough construction work, moving earth and loading gravel. Excellent manoeuvrability makes this allrounder perfect for different jobs in industries, recycling terminals, and saw mills.

## Powerful L90F

The powerful Volvo L90F is the wheel loader for gravel pits, harbours, goods terminals, industries, and logging yards. Volvo's TP-linkage, attachment bracket, and genuine Volvo attachments make the flexible L90F even more of an allrounder. So flexible that one machine is enough, where others need two.

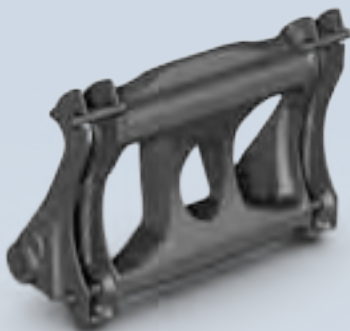



# ATTACH A NEW BUSINESS IDEA

You don't have to buy a new machine every time you want to do new business. With genuine Volvo attachments and hydraulic attachment bracket, you can change business just like that on the move. The Volvo's value as an allrounder grows with the number of different applications it can handle. And the number of genuine attachments – attachments that do your wheel loader full justice – increases steadily.

## **Ideal partners for every job**

All genuine Volvo attachments are of the same high quality as the rest of the machine. Every attachment is designed as an integrated part of the wheel loader. Their functions and properties are precisely matched to parameters such as link arm geometry and breakout, rim-pull, and lifting force. In short, they are made for each other and ideal partners for every job.

## **The right attachments for your work site**

Volvo's complete attachment range makes it possible to tailor the wheel loader exactly for the applications and conditions on your work site. Genuine Volvo attachments offer buckets for all types of jobs and materials, log grapples, material handling arms, and a long line of different fork attachments. The perfect connection between bracket and attachment is a guarantee for high safety on your work site.





# POWER YOUR CREATIVITY

Volvo's in-house manufactured drivetrain, hydraulics, and TP-linkage are tailored to work together in perfect harmony. The power comes from the latest generation of quiet, environmentally-friendly engines. Volvo's load-sensing hydraulic system contributes to the low fuel consumption by always delivering the right power to the right function, without unnecessary pumping of the oil.

## **Quiet low-emission engine meets new legislation**

The environment-friendly engine delivers high torque near idle rpm which gives the Volvo excellent rimpull, low fuel consumption, and minimal emissions. The external sound level meets the requirements according to new EU legislation. Lower sound level in the cab also contributes to higher operator comfort and performance.

## **Automatic Power Shift (APS) always selects the right gear**

Volvo Automatic Power Shift is the starting point for fast and efficient work cycles. The system is dependent of machine speed and engine rpm. All the operator has to do is select forward or reverse. APS adapts to the operator's operating style and saves fuel by always selecting the right gear.

## **In-house developed axles**

Volvo's axles are an integrated part of the drivetrain – an effective power pack, dimensioned to provide top reliability.

## **Smooth and effective braking**

Volvo L60F, L70F, and L90F are equipped with Volvo's wet, circulation-cooled disc brakes. They have long operating life and give smooth and effective braking action.



## **Fuel-efficient Volvo V-ACT D6E engines**

Turbocharged low-emission, high-performance engine with air-air intercooler

Electronic engine control with overspeed protection for optimal performance in all operating situations

Hydrostatically driven, electronically controlled cooling fan works only when needed, which saves fuel

## **Smooth shifting electric-hydraulic HTE transmission**

Fuel-saving APS selects the right gear for the job, current operating conditions.

Smooth shifts and high comfort with Pulse Width Modulation (PWM) gear selector valve

Four gears forward, four reverse

The transmission features automatic downshift to 1st gear when there's a need for extra power

## **Axles**

100 percent lockable differential lock on the front axle for best traction in difficult conditions

Lubricated-for-life rear axle bearings promote higher uptime and longer service life

## **Wet disc brakes for greater safety**

All-hydraulic dual circuit system for greater safety

Contronic performs electronic brake test

Simple checking of brake pads with brake wear indicator on all wheels





# YOU ARE LOOKING AT THE HEIGHT OF PRECISION

Precision-control, optimized visibility of the attachment throughout the entire lifting range, and fingertip operation of the load-sensing hydraulics give the operator complete control of the most demanding tasks. This means higher safety and faster work cycles in all types of jobs.

## **Complete control all the way**

Volvo's patented lift arm system TP-linkage combines high breakout torque and excellent parallel movement throughout the entire lifting range. That's exactly what an allrounder needs. The system is operator-friendly and gives the operator good control of heavy loads all the way up when loading.

## **The right power, regardless of engine rpm**

Volvo's wheel loaders feature an intelligent load-sensing hydraulic system, providing exact distribution of power when and where it's needed, regardless of engine rpm. The system makes the wheel loader easy to operate, saves fuel, and assists the operator in controlling both machine and load.

## **Easy precision steering**

The precision steering is easily operated and exact even at low engine rpm. The hydrostatic, load-sensing steering system only works when you turn the steering wheel, which means fuel savings.

## **Smooth and comfortable ride**

The long wheel base enables Volvo's wheel loaders to ride smoothly and comfortably on rough ground. The Boom Suspension System (BSS)\* increases productivity by up to 20 percent, and is available as an option.

## **Load-sensing steering**

Saves fuel by only using power when you steer

Provides increased comfort and operating safety

## **TP-linkage combines power and precision**

Volvo's patented lift arm system

Combines the best of parallel and Z-bar linkages

## **Load-sensing hydraulic system**

Saves fuel by no unnecessary pumping of hydraulic oil

Fingertip operation and control of the attachment

3rd\* and 4th\* hydraulic functions enables use of hydraulically attachments

## **Frame**

Rugged frame design for secure mounting of components increases the service life of the machine

Volvo's frame joint bearing design is a well-proven concept that's easy to maintain and renowned for its long service life

\*Optional equipment





# PROTECT YOUR PRODUCTIVITY

The new generation's Volvo Care Cab is quieter, cleaner, and roomier. Visibility has been improved and the cab is safer, both inside and outside. Comfort has been improved with Automatic Heat Control and better vibration damping. The result is the best Care Cab we've ever built. Simply put – the industry's most effective workplace.

## Volvo protects against dust

The right cab climate helps the operator stay sharp right to the end of the shift. Volvo Care Cab has a unique filter system which gives one of the market's cleanest cab environments. All cab air is filtered through double filters. On very dusty work sites, the operator can choose endless variable recirculation of up to 90 percent temperature-controlled air, and to only let in 10 percent outdoor air.

## Care Cab spares backs and shoulders

Volvo Care Cab is an ergonomically designed workplace. All instruments are easy to read and all important information is grouped in front of the operator. Several seats and adjustment features make it easy to find a comfortable operating position. The forward-reverse function is available both in the lever to the left of the steering wheel and in the hydraulic console for the right hand. With lever steering, Comfort Drive Control (CDC)\* the operator can handle steering, shifting forward-reverse, and kick-down with controls in the left armrest to avoid static muscle loads.



## Care Cab - a more effective workplace

Comfortable cab climate with the market's best filter system

Adjustable steering wheel, seat, armrest\*, and lever carrier

New viscous cab mounts unwanted noise and vibrations are further dampened

Improved visibility all around the machine increases safety on the work site

Easy-to-clean interior

Several storage compartments

Laminated front windshield protects the operator

Practical sliding window

Well-placed handrails improve safety

Powerful halogen work lights front and rear give good visibility of the whole operating area

\* Optional equipment





# REAL-TIME INTELLIGENCE SUPPORTS MORE UPTIME

Just like the operator, the turbo diesel engine also needs to breathe clean, cooled air, even in the toughest conditions. Volvo's care for the operator and machine means that most problems that can be caused by particles are filtered away. Contronic real-time intelligence will find and delete the rest. The Contronic system works in three ways. It warns the operator in time, troubleshoots and stores operating data for the service technician, and helps the machine owner to adapt the wheel loader to new operating conditions.

## Let Contronic take control

Service-friendliness is important to your productivity. The more you are going to use the wheel loader, the more important it is to be able to perform daily service fast and easy. That's why all filters and service points are easily accessed on a Volvo, and all hatches are large and easy to open. Volvo Contronic handles some of the daily checks by fast and easy electronic level checks of oils and fluids. Contronic is an integrated network that continuously monitors the wheel loader's operation and performance in real-time. The system works at three levels.

**Level 1:** The system keeps an eye on the machine's functions in real-time.

If something abnormal should occur, Contronic automatically generates a warning and brings the situation to the operator's attention.

A service technician can log in to the system and troubleshoot the problem directly on-site.

**Level 2:** All operating data is stored in Contronic. Data can be used to analyze how the machine is operated and to see what has happened since the last service. The information is presented in MATRIS analysis program, giving valuable information for troubleshooting and service actions.

**Level 3:** The wheel loader's functions and performance can be updated and adapted to changing operating conditions with VCADS Pro analysis and programming tool.

## Contronic electronic monitoring system

Computerized electrical and monitoring system. Reliable and operator-friendly. Coordination of operating data from engine and machine computer for optimal performance and safety.

Display information in three categories – continuous operating data, warning texts, and error messages.

Available in 24 languages, monitors fuel consumption, cycle times, and service intervals

The system has built-in safety functions that automatically restrict engine torque and power in case of major malfunction to protect engine and transmission and to minimize risk of subsequent damage.

## Maintenance and availability

Electronic monitoring of fluid levels simplifies and reduces time for daily inspections, also gives increased operating safety.

Long lubrication intervals mean more time for productive work.

Contronic generates signals for abnormalities and shows diagnosis for actions.

Well-designed steps, platforms as well as well-placed handles, for safe and comfortable service.

Breather filters give component protection for transmission, axles, fuel tank, and hydraulic oil tank.

Volvo's oil-bath pre-cleaner\*, in combination with the standard air filter, gives significantly higher effectiveness in dusty and dirty operating conditions.

Easily accessed hatches and service points facilitate service.

Pressure check connections and quick-couplings tightly grouped for fast and easy checks.

\* Optional equipment



# DON'T DISTURB YOUR ENVIRONMENT. PROTECT IT.

Quality, safety, and care for the environment are Volvo's core values. Indeed, we see our commitment as an integral part of our operation. Few machines have to work in tougher conditions. The ultimate goal is maximized productivity and efficiency for the lowest cost per hour, with minimized environmental impact. For instance, plants and manufacturing processes are certified in accordance with ISO 14001. This is but one example of our tangible commitments and high quality standards. And that's why Volvo customers get one of the most environmentally considerate and dependable wheel loaders on the market.

## **Powerful, dependable, and environmentally optimized**

With the new generation of turbocharged diesel engines, Volvo has taken another major step in reducing emissions, without impact on engine performance. Volvo Advanced Combustion Technology, V-ACT, makes it possible, with advanced fuel injection and electronic engine control, meaning that every drop of fuel is used. A smart system for internal recirculation of exhausts, I-EGR, reduces the NOx-value by reducing peak combustion temperatures.

## **More than 95 percent recyclable**

Volvo's core values are quality, safety, and environmental care. Today, our wheel loaders are almost completely recyclable. Components such as engine, transmission, and hydraulics are overhauled and re-used in our exchange system.

## **Volvo cares about the environment**

Engine D6E meets all governing emission requirements according to step IIIA in Europe and Tier 3 in the USA

Volvo's wheel loaders are manufactured in environmentally certified plants according to ISO 14001

Load-sensing hydraulic and steering systems contribute to lower fuel consumption

More than 95 percent recyclable by weight

Low sound levels, inside and outside.

## **Volvo means quality**

Replaceable breather filters shut out dirty air from transmission, axles, fuel tank, and hydraulic tank

High-quality components that can handle tough conditions and environments

Volvo's frame joint with ingenious bearing design, renowned for its long service life

All electric cabling is well protected from water, dirt, and wear in solidly fastened, heavy-duty conduits with rubberized connectors and terminal caps.

Electrical components, including the fuse box, are well protected inside the cab.

## **Volvo means safety**

Dual circuit service brake system meets all requirements for safe and effective brake function according to ISO 3450

Electronic brake test in Contronic

Simple checking with wear indicators increases safety

The parking brake is activated automatically when the engine is switched off

Volvo Care Cab is tested and approved according to ROPS ISO 3471 and FOPS ISO 3449

Excellent allround visibility gives effective control of the work site

Sloping engine hood gives better visibility to the rear

New design of steps and platforms, with anti-slip protection and well-placed handrails

Warning decals give clear information in the form of symbols and illustrations





# MORE THAN 50 YEARS OF EXPERIENCE BUILT IN

## Load-sensing hydraulic system

- Saves fuel by no unnecessary pumping of hydraulic oil
- Pilot-operated fingertip control of the attachment
- 3rd and 4th hydraulic functions enable use of advanced attachments

## Load-sensing steering

- Saves fuel by only using power when you steer
- Gives increased comfort and operating safety

## TP-linkage combines power and precision

- Volvo's patented lift arm system
- Combines the best of parallel and Z-bar linkages

## Two machines in one

- TP-linkage, attachment bracket, and a complete range of attachments means that one Volvo is enough, where others need several machines
- With the hydraulic attachment bracket you can change business on the move
- Tailor the wheel loader exactly for the application

## Contronic increases reliability

- Network monitors operation and performance in real-time
- The Contronic system warns the operator in time, making it easier for the service technician to troubleshoot and helps the machine owner to adapt the wheel loader to the application
- Fast and easy electronic level checks of oils and fluids
- Display shows continuous operating data, warning texts, and error messages
- Monitors fuel consumption, cycle times, and service intervals
- Available in 24 languages

## Easy maintenance means higher availability

- Easily accessed hatches and service points
- Tightly grouped pressure check connections and quick-couplings
- Long lubrication intervals give more time for productive work
- Well-designed steps, handrails, and handles for safe service

## Lubricated-for-life rear axle bearings

- Promote higher uptime and longer service life





#### **Care Cab is a more effective workplace**

- Comfortable cab climate with the market's best filter system
- Adjustable steering wheel, seat, armrest\*, and lever carrier
- Viscous damping helps to eliminate unwanted noise and vibrations
- Improved allround visibility increases safety
- Laminated front windshield protects the operator
- Practical sliding window
- Halogen work lights front and rear give good visibility

#### **Fuel-efficient low-emissions, high-performance engines**

- Turbocharged Volvo V-ACT D6E engines
- Volvo's Tier 3/Stage IIIA-approved
- Engine control with overspeed protection for optimal performance in all operating conditions
- Hydrostatically driven, electronically controlled cooling fan works only when needed, which saves fuel

#### **In-house manufactured transmission and axles**

- Volvo's in-house manufactured drivetrain, hydraulics, and TP-linkage are tailored to work together in perfect harmony
- 100 percent lockable differential lock on the front axle for best traction in difficult conditions.

#### **Smooth shifting Volvo Automatic Power Shift (APS)**

- Fuel-saving APS selects the right gear for the job, current operating conditions, and the operator's operating style
- Smooth shifts and high comfort with Pulse Width Modulation (PWM) gear selector
- Four gears forward, four reverse
- The transmission automatically downshift to first gear

#### **Smooth and effective braking**

- Circulation-cooled wet disc brakes with long service life
- All-hydraulic dual circuit system increases safety
- Contronic performs electronic brake test
- Simple checking of brake discs with brake wear indicator on all wheels

#### **Volvo Frames**

- High-quality steel provides stress resistance and operational stability
- Low vibrations and incredibly quiet sound levels
- Well-organized articulation joint provides very easy access for inspection and maintenance
- Upper and lower joints designed for the highest stress ensure long life and reliability

\* Optional equipment

# BUILT TO RUN. SUPPORTED FOR LIFE.

When you invest in a Volvo wheel loader, you get a construction machine of the very highest quality. But of course, even the best machines need service and maintenance to be as productive tomorrow as they are today. Customer Support will help you to keep an eye on your owning and operating costs.

## **We care about your operation - anywhere, anytime**

Volvo Construction Equipment centers around a professional Customer Support organization, providing parts supply, aftersales services and training. All this gives customer benefits through controlled owning and operating costs. When you invest in a Volvo wheel loader, the availability of good service and access to genuine Volvo parts are just as important as the price. After all, it is the total cost during the machine's entire life that's interesting. With all the products and resources we have at our disposal, we can offer you the best support. Anywhere, anytime.

## **Four levels of support, one level of care**

The best way to get the most out of your Volvo wheel loader is to invest in a Volvo Customer Support Agreement. There are four levels of agreements designed to give you total peace of mind; white, blue, silver, and – of course – gold, which includes all service, maintenance, and repairs during the whole contract period at a fixed price. From this completely flexible starting point, we can create an agreement uniquely tailored to the needs of your business and the age of your loaders.

## **Genuine Volvo parts leave nothing to chance**

Each genuine Volvo part is developed to and manufactured together with all other machine components. It's a complete system where each part works in perfect harmony with other parts. Only by using genuine parts can you be sure that your machine retains the qualities and features we gave it from the beginning.



# JOB SATISFACTION COMES STANDARD. HERE ARE YOUR OPTIONS



## Selection of Volvo optional equipment

### Boom Suspension System (BSS)

The Boom Suspension System absorbs shocks, eliminates rocking and bouncing, and smoothes out rough roads. BSS contributes to higher productivity, less spill, and better operator comfort

### Long boom

A long boom gives the extra dump height and reach necessary for loading high trucks or feeders. The additional reach also gives added protection when loading the bucket by keeping the machine further away from the material.

### Comfort Drive Control (CDC)

Lever steering CDC enables the operator to handle steering, shifting forward-reverse, and kick-down with controls in the left armrest. At any time, the operator can change between steering with steering wheel and CDC to avoid static muscle loads.

### Automatic Lubrication System

Our factory-installed Automatic Lubrication System takes care of greasing while the machine is in operation. This means less downtime for scheduled maintenance and more time for productive work.

### Single lever

An optional pilot-control.

### 3rd and 4th hydraulic function

Enable use of advanced attachments, e.g., V-plough and log grapple with heel kick-out

### CareTrack telematics system

Remote monitoring of the machine's position, utilization, and performance. Forwarding of error codes, alarms, and service reminders. Position on map plus Geo & Time-fence functions.

### Mudguards

Front and rear mudguards – to protect the machine in extreme environments.

### Guards protect both operator and machine

Waste handling is tough work. Special pre-cleaners, air intake protection, and multiple guards such as windshield, belly, hinge, and hose guards keep both operator and wheel loader well protected from dust and debris.

# VOLVO L60F, L70F, L90F IN DETAIL



## Engine

**Engine:** Volvo's V-ACT Tier 3 /Stage IIIA-approved, 6 liter, 6-cylinder straight turbocharged diesel engine with Common Rail fuel injection system and switchable internal Exhaust Gas Recirculation (I-EGR). The engine has wet replaceable cylinder liners and replaceable valve guides and valve seats. The throttle application is transmitted electrically from the throttle pedal or the optional hand throttle.

**Air cleaning:** Three-stage Cyclone precleaner - primary filter - secondary filter.

**Cooling system:** Air-to-air intercooler and hydrostatic, electronically controlled fan.

## L60F

Engine	Volvo D6E LCE3
Max power at	28,3 r/s (1700 r/min)
SAE J1995 gross	115 kW (156 metric hp)
ISO 9249, SAE J1349 net	114 kW (155 metric hp)
Max torque at	26,7 r/s (1600 r/min)
SAE J1995 gross	680 Nm
ISO 9249, SAE J1349 net	648 Nm
Economic working range	1100-1600 r/min
Displacement	5,7 l

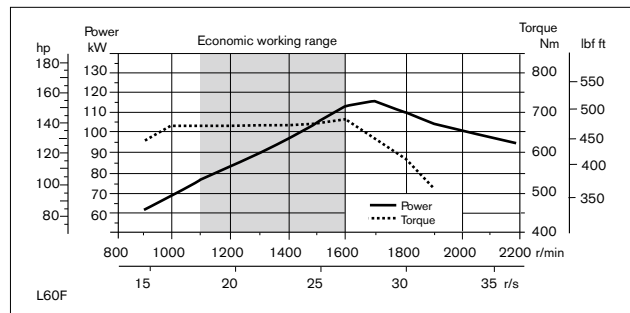

## L70F

Engine	Volvo D6E LBE3
Max power at	28,3 r/s (1700 r/min)
SAE J1995 gross	126 kW (171 metric hp)
ISO 9249, SAE J1349 net	125 kW (170 metric hp)
Max torque at	26,7 r/s (1600 r/min)
SAE J1995 gross	750 Nm
ISO 9249, SAE J1349 net	717 Nm
Economic working range	1100-1600 r/min
Displacement	5,7 l

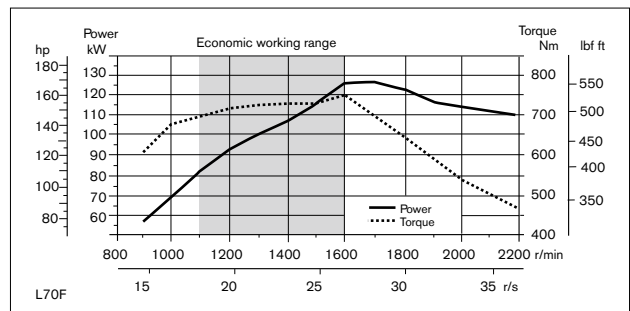

## L90F

Engine	Volvo D6E LAE3
Max power at	28,3 r/s (1700 r/min)
SAE J1995 gross	129 kW (175 metric hp)
ISO 9249, SAE J1349 net	128 kW (174 metric hp)
Max torque at	26,7 r/s (1600 r/min)
SAE J1995 gross	770 Nm
ISO 9249, SAE J1349 net	736 Nm
Economic working range	1100-1600 r/min
Displacement	5,7 l

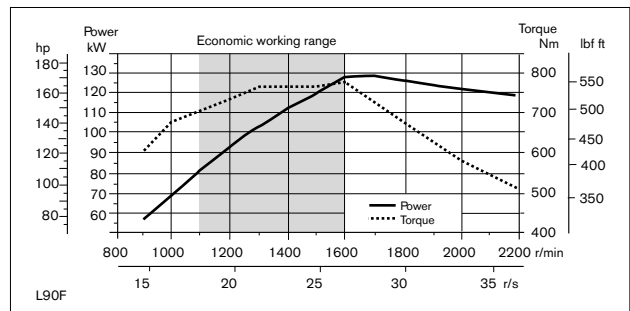



### Drivetrain

**Torque converter:** single-stage. **Transmission:** Volvo countershaft transmission with single lever control. Fast and smooth shifting of gears with Pulse Width Modulation (PWM) valve. **Gearshifting system:** Volvo Automatic Power Shift (APS) with fully automatic shifting 1-4 and mode selector with 4 different gearshifting programs, including AUTO mode. **Axles:** Volvo fully floating axle shafts with planetary hub reductions and cast steel axle housing. Fixed front axle and oscillating rear axle. 100% differential lock on the front axle.

#### L60F

Transmission	Volvo HTE 110
Torque multiplication	2,85:1
Maximum speed, forward/reverse	
1st gear	7,3 km/h
2nd gear	14,2 km/h
3rd gear	27,1 km/h
4th gear (limited by ECU)	43,1 km/h*
Measured with tires	20.5 R25 L2
Front axle/rear axle	Volvo/AWB 15/15
Rear axle oscillation	±13°
Ground clearance at 13° osc.	470 mm

#### L70F

Transmission	Volvo HTE 120
Torque multiplication	2,67:1
Maximum speed, forward/reverse	
1st gear	7,4 km/h
2nd gear	14,4 km/h
3rd gear	27,6 km/h
4th gear (limited by ECU)	44,5 km/h*
Measured with tires	20.5 R25 L2
Front axle/rear axle	Volvo/AWB 25/20
Rear axle oscillation	±13°
Ground clearance at 13° osc.	470 mm

#### L90F

Transmission	Volvo HTE 125
Torque multiplication	2,45:1
Maximum speed, forward/reverse	
1st gear	6,7 km/h
2nd gear	13,0 km/h
3rd gear	25,1 km/h
4th (limited by ECU)	46,2 km/h*
Measured with tires	20.5 R25 L2
Front axle/rear axle	Volvo AWB25/AWB20
Rear axle oscillation	±13°
Ground clearance at 13° osc.	470 mm

\* local restrictions may apply

### Electrical system

Contronic electrical system with central warning light and buzzer for following functions: - Serious engine fault - Low steering system pressure - Over speed warning engine - Interruption in communication (computer fault) Central warning light and buzzer with the gear engaged for the following functions. - Low engine oil pressure - High engine oil temperature - High charge air temperature - Low coolant level - High coolant temperature - High crank case pressure - Low transmission oil pressure - High transmission oil temperature - Low brake pressure - Engaged parking brake - Fault on brake charging - Low hydraulic oil level - High hydraulic oil temperature - Overspeeding in engaged gear - High brake cooling oil temperature front and rear axles

#### L60F, L70F, L90F

Voltage	24 V
Batteries	2x12 V
Battery capacity	2x110 Ah
Cold cranking capacity, approx	690 A
Reserve capacity	206 min
Alternator rating	2280 W/80 A
Starter motor output	5,5 kW (7,5 hp)

### Brake system

**Service brake:** Volvo dual-circuit system with nitrogen charged accumulators. Outboard mounted hydraulically operated, fully sealed oil circulation-cooled wet disc brakes. The operator can select automatic disengagement of the transmission when braking using Contronic. **Parking brake:** Dry disc brake mounted on the transmission output shaft. Applied by spring force and electro-hydraulically released with a switch on the instrument panel. **Secondary brake:** Dual brake circuits with rechargeable accumulators. Either one circuit or the parking brake fulfills all safety requirements. **Standard:** The brake system complies with the requirements of ISO 3450.

#### L60F

Number of brake discs per wheel front/rear	1/1
Accumulators	3x0,5 l
Accumulators for parking brake	1x0,5 l

#### L70F

Number of brake discs per wheel front/rear	1/1
Accumulators	2x0,5 l, 1x1,0 l
Accumulators for parking brake	1x1,0 l

#### L90F

Number of brake discs per wheel front/rear	1/1
Accumulators	2x0,5 l, 1x1,0 l
Accumulators for parking brake	1x1,0 l

# VOLVO L60F, L70F, L90F IN DETAIL



## Cab

**Instrumentation:** All important information is centrally located in the operator's field of vision. Display for Contronic monitoring system. **Heater and defroster:** Heater coil with filtered fresh air and fan with auto and 11 speeds. Defroster vents for all window areas. **Operator's seat:** Operator's seat with adjustable suspension and retractable seatbelt. The seat is mounted on a bracket on the rear cab wall and floor. The forces from the retractable seatbelt are absorbed by the seat rails. **Standard:** The cab is tested and approved according to ROPS (ISO 3471, SAE J1040), FOPS (ISO 3449). The cab meets with requirements according to ISO 6055 (Operator overhead protection - Industrial trucks) and SAE J386 ("Operator Restraint System").

## L60F

<b>Emergency exit</b>	Use emergency hammer to break window
<b>Sound level in cab according to ISO 6396</b>	LpA 68 dB (A)*
<b>Sound level in cab according to ISO 6396</b>	LpA 70 dB (A)
<b>External sound level according to ISO 6395</b>	LwA 104 dB (A)*
<b>External sound level according to ISO 6395</b>	LwA 107 dB (A)
<b>Ventilation</b>	9 m <sup>3</sup> /min
<b>Heating capacity</b>	11 kW
<b>Air conditioning (optional)</b>	8 kW

## L70F

<b>Emergency exit</b>	Use emergency hammer to break window
<b>Sound level in cab according to ISO 6396</b>	LpA 68 dB (A)*
<b>Sound level in cab according to ISO 6396</b>	LpA 70 dB (A)
<b>External sound level according to ISO 6395</b>	LwA 105 dB (A)*
<b>External sound level according to ISO 6395</b>	LwA 108 dB (A)
<b>Ventilation</b>	9 m <sup>3</sup> /min
<b>Heating capacity</b>	11 kW
<b>Air conditioning (optional)</b>	8 kW

## L90F

<b>Emergency exit</b>	Use emergency hammer to break window
<b>Sound level in cab according to ISO 6396</b>	LpA 68 dB (A)*
<b>Sound level in cab according to ISO 6396</b>	LpA 70 dB (A)
<b>External sound level according to ISO 6395</b>	LwA 105 dB (A)*
<b>External sound level according to ISO 6395</b>	LwA 108 dB (A)
<b>Ventilation</b>	9 m <sup>3</sup> /min
<b>Heating capacity</b>	11 kW
<b>Air conditioning (optional)</b>	8 kW

## Lift arm system

Torque Parallel linkage (TP linkage) with high breakout torque and parallel action throughout the entire lifting range.

## L60F

<b>Lift cylinders</b>	2
<b>Cylinder bore</b>	110 mm
<b>Piston rod diameter</b>	70 mm
<b>Stroke</b>	665 mm
<b>Tilt cylinder</b>	1
<b>Cylinder bore</b>	150 mm
<b>Piston rod diameter</b>	80 mm
<b>Stroke</b>	444 mm

## L70F

<b>Lift cylinders</b>	2
<b>Cylinder bore</b>	110 mm
<b>Piston rod diameter</b>	70 mm
<b>Stroke</b>	756 mm
<b>Tilt cylinder</b>	1
<b>Cylinder bore</b>	160 mm
<b>Piston rod diameter</b>	90 mm
<b>Stroke</b>	432 mm

## L90F

<b>Lift cylinders</b>	2
<b>Cylinder bore</b>	120 mm
<b>Piston rod diameter</b>	70 mm
<b>Stroke</b>	733 mm
<b>Tilt cylinder</b>	1
<b>Cylinder bore</b>	180 mm
<b>Piston rod diameter</b>	90 mm
<b>Stroke</b>	430 mm

\* with optional noise reduction kit EU





### Hydraulic system

**System supply:** One load-sensing axial piston pumps with variable displacement. The steering function always has priority. **Valves:** Double-acting 2-spool valve. The main valve is controlled by a 2-spool pilot valve. **Lift function:** The valve has four positions; lift, hold, lower, and float position. Inductive/magnetic automatic boom kick-out can be switched on and off and is adjustable to any position between maximum reach and full lifting height. **Tilt function:** The valve has three functions: rollback, hold and dump. Inductive/magnetic automatic tilt can be adjusted to the desired bucket angle. **Cylinders:** Double-acting cylinders for all functions. **Filter:** Full-flow filtration through 20 micron (absolute) filter cartridge.

#### L60F

Working pressure, maximum	26,0 MPa
Flow at engine speed	145 l/min 10 MPa 32 r/s (1900 r/min)
Pilot system, working pressure	3,0 MPa
Cycle times	
Raise*	4,5 s
Tilt*	2,3 s
Lower, empty	2,9 s
Total cycle time	9,7 s

#### L70F

Working pressure, maximum	26,0 MPa
Flow at engine speed	154 l/min 10 MPa 32 r/s (1900 r/min)
Pilot system, working pressure	3,0 MPa
Cycle times	
Raise*	5,3 s
Tilt*	1,3 s
Lower, empty	2,7 s
Total cycle time	9,3 s

#### L90F

Working pressure, maximum	26,0 MPa
Flow at engine speed	162 l/min 10 MPa 32 r/s (1900 r/min)
Pilot system, working pressure	3,0 MPa
Cycle times	
Raise*	5,4 s
Tilt*	2,1 s
Lower, empty	2,5 s
Total cycle time	10,0 s

### Steering system

**Steering system:** Load-sensing hydrostatic articulated steering. **System supply:** The steering system has priority feed from a load-sensing axial piston pump with variable displacement. **Steering cylinders:** Two double-acting cylinders.

#### L60F

Steering cylinders	2
Cylinder bore	70 mm
Rod diameter	45 mm
Stroke	386 mm
Working pressure	21 MPa
Maximum flow	145 l/min
Maximum articulation	±40°

#### L70F

Steering cylinders	2
Cylinder bore	70 mm
Rod diameter	45 mm
Stroke	386 mm
Working pressure	21 MPa
Maximum flow	154 l/min
Maximum articulation	±40°

#### L90F

Steering cylinders	2
Cylinder bore	80 mm
Rod diameter	50 mm
Stroke	345 mm
Working pressure	21 MPa
Maximum flow	162 l/min
Maximum articulation	±40°

\* with load as per ISO 14397

# VOLVO L60F, L70F, L90F IN DETAIL



## Service

**Service accessibility:** Large, easy-to-open service doors with gas struts. Swing-out radiator grill. Fluid filters and component breather filters promote long service intervals. Possibility to log and analyze data to facilitate troubleshooting.

### L60F refill capacities

Fuel tank	224 l
Engine coolant	30 l
Hydraulic oil tank	90 l
Transmission oil	20 l
Engine oil	20 l
Axle oil front/rear	24/24 l

### L70F refill capacities

Fuel tank	224 l
Engine coolant	30 l
Hydraulic oil tank	90 l
Transmission oil	20 l
Engine oil	20 l
Axle oil front/rear	35/27 l

### L90F refill capacities

Fuel tank	224 l
Engine coolant	30 l
Hydraulic oil tank	90 l
Transmission oil	21 l
Engine oil	20 l
Axle oil front/rear	35/27 l





# SPECIFICATIONS

Tires: 20.5 R25 L2

	Standard boom			Long boom		
	L60F	L70F	L90F	L60F	L70F	L90F
B	5990 mm	6050 mm	6120 mm	6500 mm	6530 mm	6550 mm
C	3000 mm	3000 mm	3000 mm	-	-	-
D	460 mm	460 mm	460 mm	-	-	-
F	3220 mm	3280 mm	3280 mm	-	-	-
G	2130 mm	2130 mm	2130 mm	-	-	-
J	3580 mm	3580 mm	3650 mm	4100 mm	4050 mm	4080 mm
K	3870 mm	3870 mm	3960 mm	4390 mm	4340 mm	4390 mm
O	56 °	56 °	57 °	57 °	52 °	57 °
P <sub>max</sub>	45 °	46 °	44 °	44 °	45 °	-
R	42 °	42 °	44 °	43 °	44 °	47 °
R <sub>1</sub> *	47 °	48 °	49 °	50 °	52 °	53 °
S	79 °	68 °	67 °	-	72 °	65 °
T	93 mm	110 mm	110 mm	130 mm	118 mm	116 mm
U	450 mm	450 mm	490 mm	590 mm	560 mm	590 mm
X	1900 mm	1930 mm	1960 mm	-	-	-
Y	2440 mm	2470 mm	2490 mm	-	-	-
Z	3210 mm	3200 mm	3300 mm	3600 mm	3500 mm	3660 mm
a <sub>2</sub>	5340 mm	5350 mm	5370 mm	-	-	-
a <sub>3</sub>	2900 mm	2890 mm	2880 mm	-	-	-
a <sub>4</sub>	±40 °	±40 °	±40 °	-	-	-

\* Carry position SAE

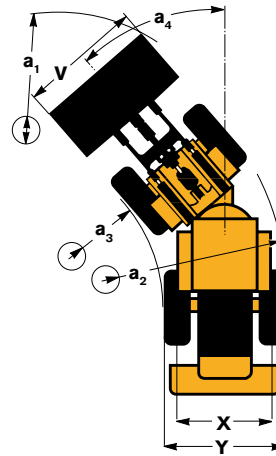

Where applicable, specifications and dimensions are according to ISO 7131, SAE J732, ISO 7546, SAE J742, ISO 14397, SAE J818.

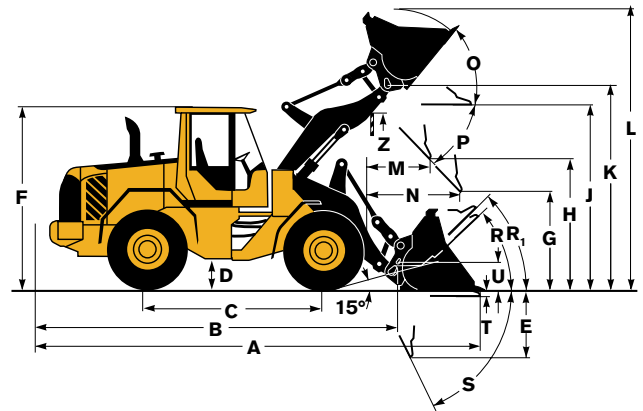

Tires: 20.5 R25 L2

	L60F	L70F	L90F
A	800 mm	830 mm	960 mm
B	1560 mm	1600 mm	1700 mm
C	-40 mm	-46 mm	-8 mm
D	1830 mm	1850 mm	1790 mm
E	3710 mm	3730 mm	3770 mm
F	690 mm	760 mm	740 mm
Operating load* at load rated distance	4350 kg 600 mm	4900 kg 600 mm	5700 kg 600 mm
Operating weight	11 450 kg	12 950 kg	14 500 kg

Fork tine sales code L60F and L70F (R/L): WLA80042/80043

Fork tine sales code L90F (R/L): WLA80344/80345

Length: 1200 mm

Fork frame order no.: 80041

\* acc. std EN 474-3, firm and level ground

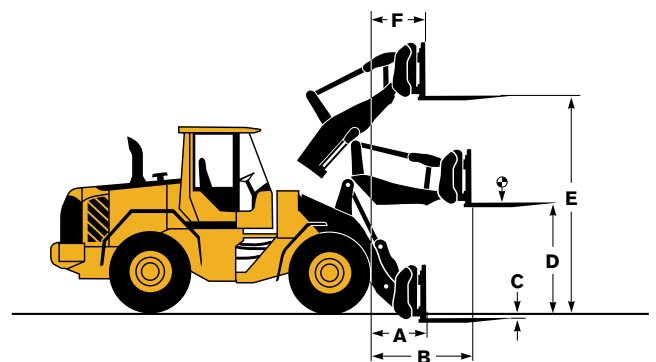

Tires: 20.5 R25 L2

	L60F	L70F	L90F
A*	1800 kg	2150 kg	2760 kg
B*	1400 kg	1710 kg	2130 kg
C*	1150 kg	1400 kg	1740 kg
D	2580 mm	2720 mm	2640 mm
E	1990 mm	2110 mm	2040 mm
F	1450 mm	1550 mm	1440 mm
G	3270 mm	3320 mm	3280 mm
H	4300 mm	4360 mm	4410 mm
I	5440 mm	5490 mm	5550 mm
J	910 mm	1270 mm	1370 mm
K	1240 mm	1750 mm	1920 mm
L	1590 mm	2270 mm	2470 mm
M	2250 mm	2180 mm	2040 mm
N	3230 mm	3100 mm	3030 mm
O	4310 mm	4110 mm	4020 mm
P	1520 mm	1520 mm	1530 mm
Q	5300 mm	5290 mm	5330 mm
R	6180 mm	6170 mm	6290 mm
S	7150 mm	7120 mm	7250 mm

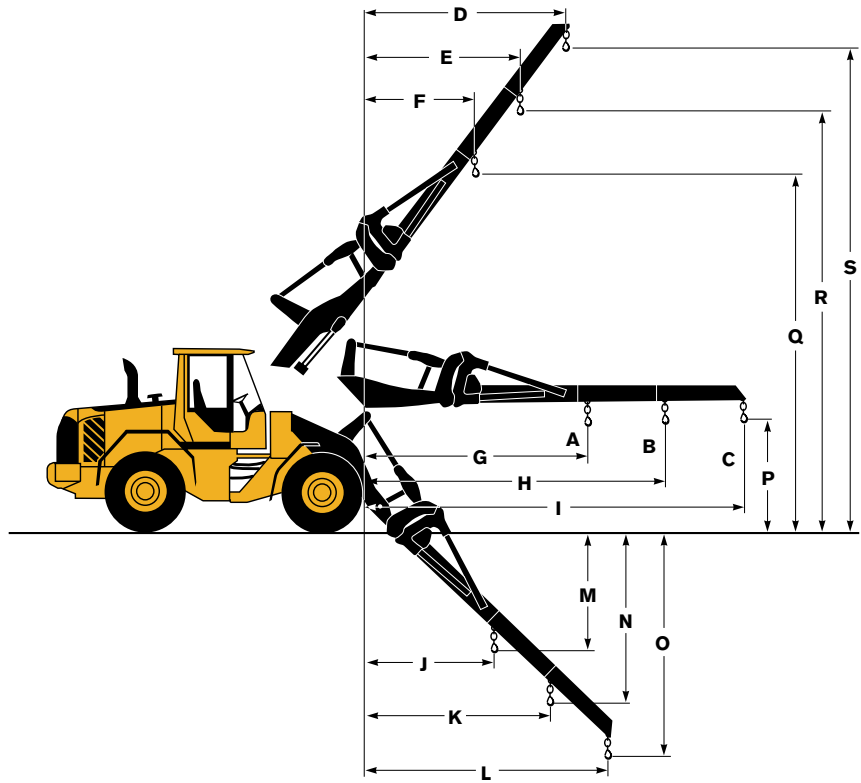

L60F

Sales code: WLA92007  
Operating weight: 11 370 kg

L70F

Sales code: WLA92007  
Operating weight: 12 860 kg

L90F

Sales code: WLA92008  
Operating weight: 14 440 kg

\* Carry position SAE

Tires: 20.5 R25 L2

	L60F	L70F	L90F
A	1,3 m <sup>2</sup>	1,5 m <sup>2</sup>	2,4 m <sup>2</sup>
B	3420 mm	3380 mm	3420 mm
C	1480 mm	1600 mm	1830 mm
D	2940 mm	2870 mm	2790 mm
E	1170 mm	1270 mm	1440 mm
F	1540 mm	1500 mm	1440 mm
G	2350 mm	2440 mm	2770 mm
H	4340 mm	4380 mm	4540 mm
I	5890 mm	6030 mm	6580 mm
J	2000 mm	2140 mm	2790 mm
K	2080 mm	2370 mm	2990 mm
L	1700 mm	1800 mm	2160 mm
M	7830 mm	7960 mm	8420 mm

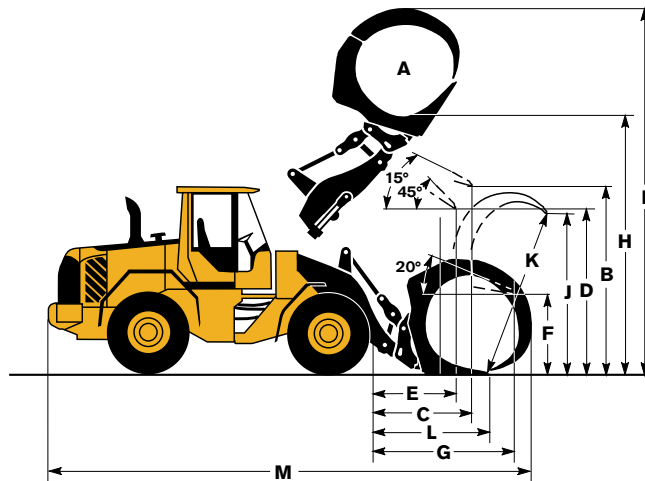

L60F

Sales code: WLA82194  
Operating weight  
(incl. logging cw 120 kg): 12 210 kg  
Operating load: 3450 kg









L70F

Sales code: WLA80153  
Operating weight  
(incl. logging cw 250 kg): 13 590 kg  
Operating load: 3990 kg

L90F

Sales code: WLA80832  
Operating weight  
(incl. logging cw 500 kg): 15 850 kg  
Operating load: 4600 kg

# L60F





Tires 20.5 R25 L2	GENERAL PURPOSE						GRADING	LIGHT MATERIAL		LONG BOOM	
											
	Bolt-on edges	Teeth	Bolt-on edges	Bolt-on edges	Bolt-on edges	Bolt-on edges		Bolt-on edges	Bolt-on edges		
Volume, heaped ISO/SAE	m <sup>3</sup>	1,9	1,8	2,1	2,1	2,3	2,3	1,6	3,1	5,0	-
Volume at 110% fill factor	m <sup>3</sup>	2,1	2,0	2,3	2,3	2,5	2,5	1,8	3,4	5,5	-
Static tipping load, straight	kg	8120	8270	8520	8030	8440	7930	7290	7740	7720	-1700
at 35° turn	kg	7260	7410	7640	7170	7560	7930	6540	6900	6850	-1570
at full turn	kg	7010	7150	7380	6920	7300	6820	6310	6660	6600	-1530
Breakout force	kN	80,1	84,2	82,9	76,1	78,9	72,8	62,4	61,7	53,9	+9,0
A	mm	7310	7420	7270	7370	7340	7440	7540	7650	7880	+520
E	mm	1130	1260	1100	1190	1160	1250	1330	1470	1690	+40
H*)	mm	2810	2740	2830	2770	2790	2730	2580	2590	2440	+530
L	mm	5120	5120	5120	5180	5200	5250	4540	5290	5490	+520
M*)	mm	1040	1160	1010	1090	1050	1140	1100	1320	1500	-7,0
N*)	mm	1590	1660	1580	1610	1590	1630	1510	1630	1680	+440
V	mm	2500	2500	2500	2500	2500	2500	2500	2550	2650	-
a, clearance circle	mm	11 590	11 660	11 590	11 630	11 620	11 660	11 920	11 830	12 060	-
Operating weight	kg	11 800	11 740	11 600	11 840	11 640	11 890	11 630	11 940	12 220	+160

\*) Measured to the tip of the bucket teeth or bolt-on edge. Dump height to bucket edge  
Measured at 45° dump angle.

Note: This only applies to genuine Volvo attachments.

## Bucket Selection Chart

The chosen bucket is determined by the density of the material and the expected bucket fill factor. The actual bucket volume is often larger than the rated capacity, due to the features of the TP linkage, including an open bucket design, good rollback angles in all positions and good bucket filling performance. The example represents a standard boom configuration.  
Example: Sand and gravel. Fill factor ~ 105%. Density 1,65 t/m<sup>3</sup>. Result: The 1,9 m<sup>3</sup> bucket carries 2,0 m<sup>3</sup>. For optimal stability always consult the bucket selection chart.

Material	Bucket fill, %		Material density, t/m <sup>3</sup>	ISO/SAE bucket volume, m <sup>3</sup>	Actual volume, m <sup>3</sup>
Earth/Clay	~ 110		~ 1,55	1,9	~ 2,1
			~ 1,40	2,1	~ 2,3
			~ 1,30	2,3	~ 2,5
Sand/Gravel	~ 105		~ 1,65	1,9	~ 2,0
			~ 1,50	2,1	~ 2,2
			~ 1,35	2,3	~ 2,1
Aggregate	~ 100		~ 1,75	1,9	~ 1,9
			~ 1,55	2,1	~ 2,1
			~ 1,55	2,3	~ 2,3
Rock	≤100		~ 1,70	1,6	~ 1,6



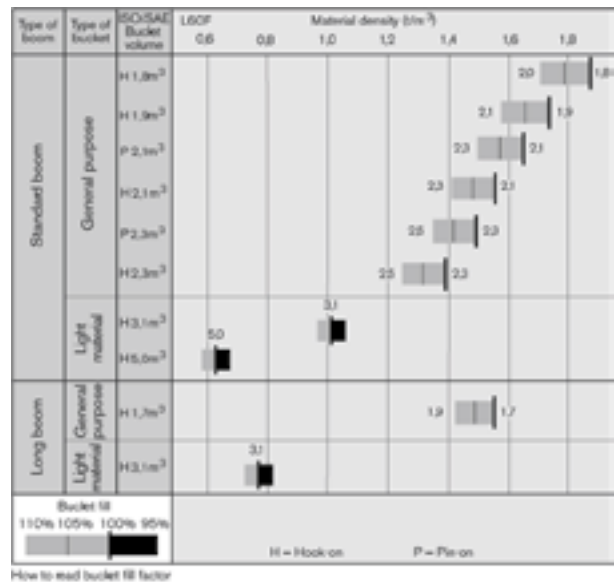





The size of rock buckets is optimized for optimal penetration and filling capability rather than the density of the material.



## Supplemental Operating Data

Tires 20.5 R25 L2		Standard boom		Long boom
		17.5 R25 L2	600/65 R25	600/65 R25
Width over tires	mm	-130	+60	+60
Ground clearance	mm	-60	-20	-20
Tipping load, full turn	kg	-310	+150	+110
Operating weight	kg	-560	+240	+240

# L70F





Tires 20.5 R25 L2	GENERAL PURPOSE						GRADING	LIGHT MATERIAL		LONG BOOM	
											
	Bolt-on edges	Teeth	Bolt-on edges	Bolt-on edges	Bolt-on edges	Bolt-on edges		Bolt-on edges	Bolt-on edges		
Volume, heaped ISO/SAE	m <sup>3</sup>	2,1	2,0	2,3	2,3	2,4	2,4	2,2	3,4	6,4	-
Volume at 110% fill factor	m <sup>3</sup>	2,3	2,2	2,5	2,5	2,6	2,6	2,4	3,7	7,0	-
Static tipping load, straight	kg	9250	9420	9770	9180	9730	9150	7510	8780	8350	-1770
at 35° turn	kg	8250	8410	8730	8170	8690	8140	6650	7800	7330	-1620
at full turn	kg	7950	8110	8420	7870	8380	7840	6390	7500	7030	-1580
Breakout force	kN	90,3	94,7	95,4	86,7	93,5	85,1	62,8	71,8	53,9	-2,0
A	mm	7450	7570	7390	7510	7420	7530	7920	7750	8300	+470
E	mm	1180	1300	1130	1240	1150	1260	1680	1470	1970	+30
H*)	mm	2750	2680	2790	2710	2770	2700	2350	2520	2150	+490
L	mm	5220	5220	5220	5280	5250	5310	4710	5450	5780	+470
M*)	mm	1140	1250	1090	1180	1110	1200	1350	1350	1730	-20
N*)	mm	1650	1720	1620	1660	1630	1670	1570	1680	1730	+400
V	mm	2550	2550	2550	2550	2550	2550	2650	2650	2750	-
a, clearance circle	mm	11 690	11 760	11 670	11 720	11 680	11 730	12 320	11 980	12 410	-
Operating weight	kg	13 370	13 300	13 160	13 410	13 180	13 430	13 670	13 620	14 160	+250

\*) Measured to the tip of the bucket teeth or bolt-on edge. Dump height to bucket edge. Measured at 45° dump angle.

Note: This only applies to genuine Volvo attachments.

## Bucket Selection Chart

The chosen bucket is determined by the density of the material and the expected bucket fill factor. The actual bucket volume is often larger than the rated capacity, due to the features of the TP linkage, including an open bucket design, good rollback angles in all positions and good bucket filling performance. The example represents a standard boom configuration. Example: Sand and gravel. Fill factor ~ 105%. Density 1,60 t/m<sup>3</sup>. Result: The 2,1 m<sup>3</sup> bucket carries 2,2 m<sup>3</sup>. For optimal stability always consult the bucket selection chart.

Material	Bucket fill, %		Material density, t/m <sup>3</sup>	ISO/SAE bucket volume, m <sup>3</sup>	Actual volume, m <sup>3</sup>
Earth/Clay	~ 110		~ 1,55	2,1	~ 2,3
			~ 1,45	2,3	~ 2,5
			~ 1,40	2,4	~ 2,6
Sand/Gravel	~ 105		~ 1,60	2,1	~ 2,2
			~ 1,50	2,3	~ 2,4
Aggregate	~ 100		~ 1,45	2,4	~ 2,5
			~ 1,80	2,1	~ 2,1
			~ 1,70	2,3	~ 2,3
Rock	≤ 100		~ 1,60	2,4	~ 2,4
			~ 1,70	1,6	~ 1,6

The size of rock buckets is optimized for optimal penetration and filling capability rather than the density of the material.

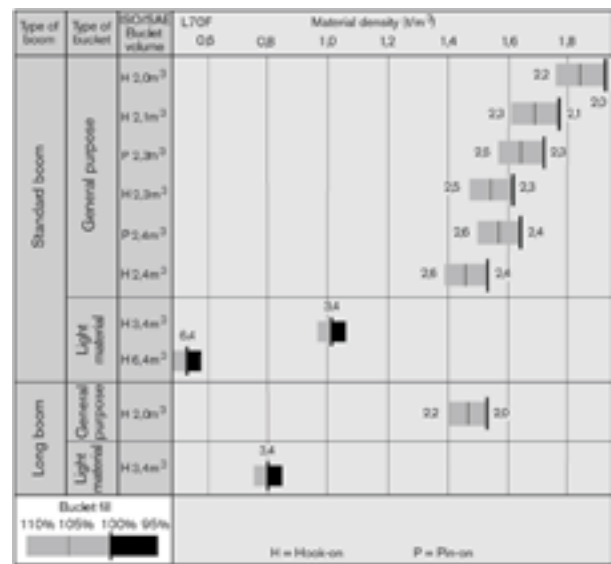











How to read bucket fill factor

## Supplemental Operating Data

Tires 20.5 R25 L2		Standard boom	Long boom
		600/65 R25	600/65 R25
Width over tires	mm	+60	+60
Ground clearance	mm	-20	-20
Tipping load, full turn	kg	+150	130
Operating weight	kg	+240	+240

# L90F





Tires 20.5 R25 L2	GENERAL PURPOSE									LIGHT MATERIAL		LONG BOOM
												
Volume, heaped ISO/SAE	m <sup>3</sup>	2,3	2,5	2,5	2,5	2,6	2,7	2,7	4,1	7,0	-	
Volume at 110% fill factor	m <sup>3</sup>	2,5	2,8	2,8	2,8	2,9	3,0	3,0	4,5	7,7	-	
Static tipping load, straight	kg	10 700	10 740	11 210	10 520	10 550	10 430	11 180	10 130	9840	-1650	
at 35° turn	kg	9470	9500	9 940	9300	9320	9200	9910	8920	8610	-1500	
at full turn	kg	9100	9140	9570	8940	8960	8840	9540	8560	8240	-1460	
Breakout force	kN	113,1	112,4	118,5	108,5	106,5	104,5	113,7	84,4	73,0	+2,0	
A	mm	7550	7810	7510	7610	7640	7670	7560	8000	8300	+410	
E	mm	1200	1430	1160	1250	1280	1300	1200	1600	1860	-6,0	
H*)	mm	2820	2650	2850	2780	2750	2740	2820	2530	2320	+420	
L	mm	5380	5460	5370	5430	5460	5490	5430	5560	5760	+420	
M*)	mm	1130	1310	1090	1170	1180	1210	1130	1470	1670	-50	
N*)	mm	1700	1770	1680	1720	1720	1730	1690	1740	1730	+360	
V	mm	2650	2650	2650	2650	2650	2750	2750	2750	3000	-	
a, clearance circle	mm	11 860	12 000	11 840	11 890	11 900	12 010	11 950	12 200	12 600	-	
Operating weight	kg	15 170	15 170	14 980	15 220	15 250	15 340	14 970	15 460	15 890	+250	

\*) Measured to the tip of the bucket teeth or bolt-on edge. Dump height to bucket edge. Measured at 45° dump angle.

Note: This only applies to genuine Volvo attachments.

## Bucket Selection Chart

The chosen bucket is determined by the density of the material and the expected bucket fill factor. The actual bucket volume is often larger than the rated capacity, due to the features of the TP linkage, including an open bucket design, good rollback angles in all positions and good bucket filling performance. The example represents a standard boom configuration. Example: Sand and gravel. Fill factor ~ 105%. Density 1,65 t/m<sup>3</sup>. Result: The 2,7 m<sup>3</sup> bucket carries 2,8 m<sup>3</sup>. For optimal stability always consult the bucket selection chart.

Material	Bucket fill, %		Material density, t/m <sup>3</sup>	ISO/SAE bucket volume, m <sup>3</sup>	Actual volume, m <sup>3</sup>
Earth/Clay	~ 110		~ 1,80	2,5	~ 2,7
			~ 1,70	2,6	~ 2,9
			~ 1,65	2,7	~ 3,0
Sand/Gravel	~ 105		~ 1,80	2,5	~ 2,6
			~ 1,70	2,6	~ 2,7
			~ 1,65	2,7	~ 2,8
Aggregate	~ 100		~ 1,80	2,5	~ 2,5
			~ 1,70	2,6	~ 2,6
			~ 1,65	2,7	~ 2,7
Rock	≤100		~ 1,80	2,2	~ 2,2

The size of rock buckets is optimized for optimal penetration and filling capability rather than the density of the material.

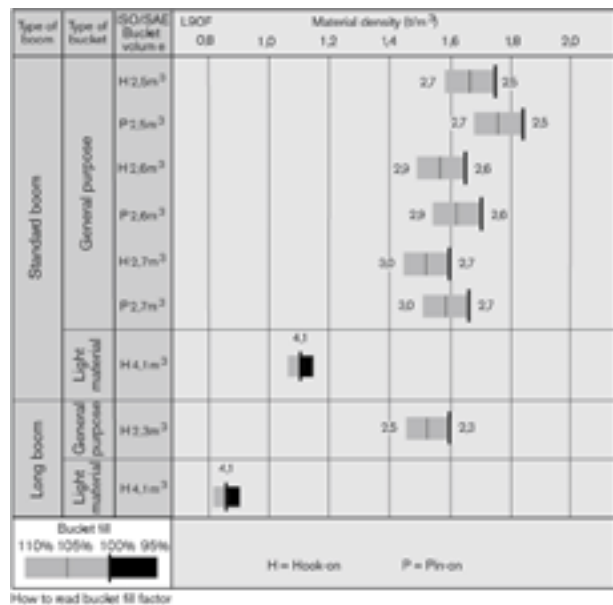

## Supplemental Operating Data

Tires 20.5 R25 L2		Standard boom	Long boom
		650/65 R25	650/65 R25
Width over tires	mm	+200	+200
Ground clearance	mm	0	0
Tipping load, full turn	kg	+400	+360
Operating weight	kg	+600	+600



## STANDARD EQUIPMENT

### Service and maintenance

	L60F	L70F	L90F
Engine oil remote drain and fill	•	•	•
Transmission oil remote drain and fill	•	•	•
Lubrication manifolds, ground accessible	•	•	•
Pressure test ports: transmission and hydraulic, quick connects	•	•	•
Tool box, lockable			•

### Engine

	L60F	L70F	L90F
Three stage air cleaner, pre-cleaner, primary and secondary filter	•	•	•
Indicator glass for coolant level	•	•	•
Preheating of induction air	•	•	•
Fuel pre-filter with water trap	•	•	•
Fuel filter	•	•	•
Crank case breather oil trap	•	•	•
Exhaust heat insulation	•	•	•

### Electrical system

	L60F	L70F	L90F
24 V, pre-wired for optional accessories	•	•	•
Alternator 24V/ 80A	•	•	•
Battery disconnect switch with removable key	•	•	•
Fuel gauge	•	•	•
Hour meter	•	•	•
Electric horn	•	•	•
Instrument cluster: <ul style="list-style-type: none"> <li>• Fuel level</li> <li>• Transmission temperature</li> <li>• Coolant temperature</li> <li>• Instrument lighting</li> </ul>	•	•	•
Lighting: <ul style="list-style-type: none"> <li>• Twin halogen front headlights with high and low beams</li> <li>• Parking lights</li> <li>• Double brake and tail lights</li> <li>• Turn signals with flashing hazard light function</li> <li>• Halogen work lights (2 front and 2 rear)</li> </ul>	•	•	•

### Contronic monitoring system

	L60F	L70F	L90F
Monitoring and logging of machine data	•	•	•
Contronic display	•	•	•
Fuel consumption	•	•	•
Ambient temperature	•	•	•
Clock	•	•	•
Test function for warning and indicator lights	•	•	•
Brake test	•	•	•
Test function, sound level at max fan speed	•	•	•
Warning and indicator lights: <ul style="list-style-type: none"> <li>• Battery charging</li> <li>• Parking brake</li> </ul>	•	•	•
Warning and display message: <ul style="list-style-type: none"> <li>• Engine coolant temperature</li> <li>• Charge air temperature</li> <li>• Engine oil temperature</li> <li>• Engine oil pressure</li> <li>• Transmission oil temperature</li> <li>• Transmission oil pressure</li> <li>• Hydraulic oil temperature</li> <li>• Brake pressure</li> <li>• Parking brake applied</li> <li>• Brake charging</li> <li>• Overspeed at direction change</li> <li>• Axle oil temperature</li> <li>• Steering pressure</li> <li>• Crank case pressure</li> <li>• Attachment lock open</li> </ul>	•	•	•
Level warnings: <ul style="list-style-type: none"> <li>• Fuel level</li> <li>• Engine oil level</li> <li>• Engine coolant level</li> <li>• Transmission oil level</li> <li>• Hydraulic oil level</li> <li>• Washer fluid level</li> </ul>	•	•	•

### L60F L70F L90F

	L60F	L70F	L90F
Engine torque reduction in case of malfunction indication: <ul style="list-style-type: none"> <li>• High engine coolant temperature</li> <li>• High engine oil temperature</li> <li>• Low engine oil pressure</li> <li>• High crank case pressure</li> <li>• High charge air temperature</li> </ul>	•	•	•
Engine shutdown to idle in case of malfunction indication: <ul style="list-style-type: none"> <li>• High transmission oil temperature</li> <li>• Slip in transmission clutches</li> </ul>	•	•	•
Key pad, background lit	•	•	•
Start interlock when gear is engaged	•	•	•

### Drivetrain

	L60F	L70F	L90F
Automatic Power Shift	•	•	•
Fully automatic gear shifting, 1-4	•	•	•
PWM-controlled gear shifting	•	•	•
Forward and reverse switch by hydraulic lever console	•	•	•
Indicator glass for transmission oil level	•	•	•
Differentials: Front, 100% hydraulic diff lock. Rear, conventional.	•	•	•

### Brake system

	L60F	L70F	L90F
Dual brake circuits	•	•	•
Dual brake pedals	•	•	•
Secondary brake system	•	•	•
Parking brake, electrical-hydraulic	•	•	•
Brake wear indicators	•	•	•

### Cab

	L60F	L70F	L90F
ROPS (ISO 3471), FOPS (ISO 3449)	•	•	•
Single key kit door/start	•	•	•
Acoustic inner lining	•	•	•
Ashtray	•	•	•
Cigarette lighter, 24 V power outlet	•	•	•
Lockable door	•	•	•
Cab heating with fresh air inlet and defroster	•	•	•
Footstep, right-hand side (tool box lockable included)	•	•	•
Fresh air inlet with two filters	•	•	•
Automatic heat control	•	•	•
Floor mat	•	•	•
Dual interior lights	•	•	•
Dual interior rear-view mirrors	•	•	•
Dual exterior rear-view mirrors	•	•	•
Sliding window, right side	•	•	•
Tinted safety glass	•	•	•
Retractable seatbelt (SAE J386)	•	•	•
Adjustable steering wheel	•	•	•
Storage compartment	•	•	•
Document pocket	•	•	•
Sun visor	•	•	•
Beverage holder	•	•	•
Windshield washer front and rear	•	•	•
Windshield wipers front and rear	•	•	•
Interval function for front and rear wipers	•	•	•

<b>Hydraulic system</b>	<b>L60F</b>	<b>L70F</b>	<b>L90F</b>
Main valve, double acting 2-spool with hydraulic pilots	•	•	•
Variable displacement axial piston pumps (2) for: • Working hydraulics, pilot hydraulics, steering system, brakes • Cooling fan, brakes	•	•	•
Hydraulic control levers	•	•	•
Electric level lock	•	•	•
Boom kick-out, automatic	•	•	•
Bucket positioner, automatic	•	•	•
Double acting hydraulic cylinders	•	•	•
Indicator glass for hydraulic oil level	•	•	•
Hydraulic oil cooler	•	•	•

<b>External equipment</b>	<b>L60F</b>	<b>L70F</b>	<b>L90F</b>
Mudguards, front and rear	•	•	•
Viscous cab mounts	•	•	•
Rubber engine and transmission mounts	•	•	•
Easy-to-open side panels	•	•	•
Frame, joint lock	•	•	•
Vandalism lock prepared for • Batteries • Engine compartment • Radiator grille	•	•	•
Lifting eyes	•	•	•
Tie down eyes	•	•	•
Tow hitch	•	•	•

#### OPTIONAL EQUIPMENT (Standard on certain markets)

<b>Service and maintenance</b>	<b>L60F</b>	<b>L70F</b>	<b>L90F</b>
Automatic lubrication system	•	•	•
Automatic lubrication system for long boom	•	•	•
Automatic lubrication system for attachment bracket, cast	•	•	•
Automatic lubrication system, stainless steel	•	•	•
Automatic lubrication system, stainless steel for attachment bracket, cast	•	•	•
Grease nipple guards		•	•
Oil sampling valve	•	•	•
Refill pump for grease to lube system	•	•	•
Tool box, lockable	•	•	
Tool kit	•	•	•
Wheel nut wrench kit	•	•	•

<b>Engine</b>	<b>L60F</b>	<b>L70F</b>	<b>L90F</b>
Air pre-cleaner, cyclone type	•	•	•
Air pre-cleaner, cyclone type, two-stage			•
Air pre-cleaner, oil bath type	•	•	•
Air pre-cleaner, turbo type	•	•	•
Cooling package: Radiator, charge air cooler, hyd oil cool, corr prot	•	•	•
Engine auto shut down	•	•	•
Engine block heater, 230 V	•	•	•
ESW, Disabled engine protection	•	•	•
ESW, Increased engine protection	•	•	•
Exterior radiator air intake protection	•	•	•
Fuel fill strainer	•	•	•
Fuel heater	•	•	•
Hand throttle control	•	•	•
Max. fan speed, hot climate	•	•	•
Reversible cooling fan	•	•	•

<b>Electrical system</b>	<b>L60F</b>	<b>L70F</b>	<b>L90F</b>
Alternator, 80 A with air filter	•	•	•
Anti-theft device	•	•	•
Battery boxes, steel	•	•	•
Headlights, assym. left	•	•	•
License plate holder, lighting	•	•	•
Rear view camera incl. monitor, colour*	•	•	•
Rear view mirrors, adjustable, el.heated	•	•	•
Reduced function working lights, reverse gear activated	•	•	•
Reverse alarm	•	•	•
Side marker lamps	•	•	•
Warning beacon, rotating	•	•	•

\* Standard on certain markets

	<b>L60F</b>	<b>L70F</b>	<b>L90F</b>
Working lights, attachments	•	•	•
Working lights front, high intensity discharge (HID)	•	•	•
Working lights front, on cab, dual	•	•	•
Working lights front, extra	•	•	•
Working lights rear, on cab	•	•	•
Working lights rear, on cab, dual	•	•	•

<b>Cab</b>	<b>L60F</b>	<b>L70F</b>	<b>L90F</b>
Anchorage for Operator's Manual	•	•	•
Automatic Climate Control, ACC	•	•	•
Automatic Climate Control, ACC, corr prot. condenser	•	•	•
ACC control panel, with Fahrenheit scale	•	•	•
Asbestos dust protection filter	•	•	•
Cab air pre-cleaner, cyclone type	•	•	•
Carbon filter	•	•	•
Cover plate, under cab	•	•	•
Lunch box holder	•	•	•
Armrest, operator's seat, ISRI, left only	•	•	•
Armrest, operator's seat, KAB, left only	•	•	•
Operator's seat, KAB, air susp, heavy-duty, not for CDC and elservo	•	•	•
Operator's seat, KAB, air susp, heavy-duty, for CDC and elservo	•	•	•
Operator's seat, ISRI, air susp, heat, high back, for CDC and elservo	•	•	•
Operator's seat, ISRI, heated, high back	•	•	•
Operator's seat, ISRI, low back	•	•	•
Radio installation kit incl. 11 amp 12 volt outlet, left-side	•	•	•
Radio installation kit incl. 11 amp 12 volt outlet, right-side	•	•	•
Radio with CD player	•	•	•
Radio with cassette tape player	•	•	•
Seat-belt, 3", (width 75 mm)	•	•	•
Steering wheel knob	•	•	•
Sun blinds, rear windows	•	•	•
Sun blinds, side windows	•	•	•
Timer cab heating	•	•	•
Universal door/ignition key	•	•	•
Window, sliding, door	•	•	•

<b>Drivetrain</b>	<b>L60F</b>	<b>L70F</b>	<b>L90F</b>
Diff lock front 100%, limited slip rear	•	•	•
Speed limiter, 20 km/h	•	•	•
Speed limiter, 30 km/h	•	•	•
Speed limiter, 40 km/h	•	•	•
Wheel/axle seal guards	•	•	•

<b>Brake system</b>	<b>L60F</b>	<b>L70F</b>	<b>L90F</b>
Parking brake alarm, audible for air susp seats	•	•	•
Parking brake alarm, audible for mech susp seats	•	•	•
Stainless steel, brake lines			•

<b>Hydraulic system</b>	<b>L60F</b>	<b>L70F</b>	<b>L90F</b>
Attachment bracket, cast	•	•	•
Attachment bracket, side tilting	•	•	•
Attachment bracket, side tilting adapter	•	•	•
Mounting kit for side tilting	•	•	•
Boom suspension system (BSS)	•	•	•
Separate attachment locking, standard boom	•	•	•
Separate attachment locking, long boom	•	•	•
Adjustable flow for 3rd hydraulic function	•	•	
Arctic kit, attachment locking hoses	•	•	•
Arctic kit, pilot hoses and brake accum. incl. hydr. oil	•	•	•
Boom cylinder hose and tube guards	•	•	•
Boom cylinder hose and tube guards for long boom	•	•	•
Detent for 3rd hydraulic function	•	•	•
HD LS hydraulics, pump kit included		•	
Hydraulic fluid, biodegradable, Agrol	•	•	•
Hydraulic fluid, biodegradable, Volvo	•	•	•
Hydraulic fluid, fire resistant	•	•	•
Hydraulic fluid, for hot climate	•	•	•
Hydraulic function, 3rd	•	•	•
Hydraulic function, 3rd for long boom	•	•	•
Hydraulic function, 3rd-4th	•	•	•
Hydraulic function, 3rd-4th for long boom	•	•	•
Single acting lifting function	•	•	•
Single lever control	•	•	•
Single lever control for 3rd hydr. function	•	•	•

<b>External equipment</b>	<b>L60F</b>	<b>L70F</b>	<b>L90F</b>
Cab ladder, rubber suspended	•	•	•
Flexible rear step	•	•	•
Footsteps front frame	•	•	•
Mudguards, front for 80-series tires, steel	•	•	•
Mudflap kit for mudguards for 80-series tires, steel	•	•	•
Mudguards, full cover, rear for 80-series tires	•	•	•
Mudflap kit for mudguards, full cover for 80-series tires	•	•	•
Mudguards, basic, short, front/rear for 65-series tires	•	•	•
Mudguards, full cover, front/rear for 65-series tires	•	•	•
Mudflap kit for mudguards, full cover for 65-series tires	•	•	•
Deleted front mudguards and wideners rear	•	•	•
Long boom	•	•	•

<b>Protective equipment</b>	<b>L60F</b>	<b>L70F</b>	<b>L90F</b>
Bellyguard front	•	•	•
Bellyguard rear	•	•	•
Cover plate, heavy-duty, front frame	•	•	•
Cover plates, rear frame	•	•	•
Guards for front head lights	•	•	•
Guards for radiator grille	•	•	•
Guards for tail lights	•	•	•
Guards for tail lights, heavy-duty	•	•	•
Windows, side and rear guards	•	•	•
Windshield guard	•	•	•
Center hinge and rear frame guard	•	•	•
Corrosion protection, painting of machine	•	•	•
Corrosion protection, painting of attachment	•	•	•

<b>Other equipment</b>	<b>L60F</b>	<b>L70F</b>	<b>L90F</b>
CareTrack, GSM (Europe and North America)	•	•	•
CareTrack, GSM/Satellite (Europe and North America)	•	•	•
CE-marking	•	•	•
Comfort Drive Control (CDC)	•	•	•
Counterweight, logging	•	•	•
Counterweight, pre-drilled for optional guards	•	•	•
Secondary steering	•	•	•
Sound decal, EU	•	•	•
Noise reduction kit, EU excl. decal	•	•	•
Sign, 50 km/h	•	•	•
Sign, slow moving vehicle	•	•	•

<b>Tires and Rims</b>	<b>L60F</b>	<b>L70F</b>	<b>L90F</b>
20.5R25, 600/65R25, 17.5R25	•		
20.5R25, 600/65R25		•	
20.5R25, 650/65R25			•
• L2	•	•	•
• L3	•	•	•
• L4	•	•	•
• L5	•	•	•

<b>Attachments</b>	<b>L60F</b>	<b>L70F</b>	<b>L90F</b>
Buckets:			
• Straight with teeth or bolt-on edges	•	•	•
• Spade nose	•	•	•
• High tipping	•	•	•
• Light material	•	•	•
• Grading	•	•	•
Wear parts:			
• Bolt-on edge	•	•	•
• Bolt-on or weld-on bucket teeth	•	•	•
• Segments		•	•
• Log grapples	•	•	•
• Fork equipment	•	•	•
• Material handling arm	•	•	•
• Snow blade	•	•	•
• Broom	•	•	•
• Sand spreading bucket	•	•	•
• Bale clamp	•	•	•
• Drum rotator	•	•	•

# VOLVO CONSTRUCTION EQUIPMENT

Volvo Construction Equipment is different. Our machines are designed, built and supported in a different way. That difference comes from an engineering heritage of over 180 years. A heritage of thinking first about the people who actually use the machines. About how to help them be safer, more comfortable, more productive. About the environment we all share. The result of that thinking is a growing range of machines and a global support network dedicated to helping you do more. People around the world are proud to use Volvo.

Not all products are available in all markets. Under our policy of continuous improvement, we reserve the right to change specifications and design without prior notice. The illustrations do not necessarily show the standard version of the machine.

# **VOLVO**

**Volvo Construction Equipment**  
[www.volvoce.com](http://www.volvoce.com)

Ref. No 20000928-D  
2012.07  
Volvo, Global Marketing

English-21  
WLO